

Note: Mixer body (in wall) not included in handle kit

Note: Dimensions are nominal measurements only

SPECIFICATIONS

RECOMMENDED USE

Domestic

CONSTRUCTION

Solid Brass

WARRANTY

Structure: 25 years | Finish: 5 years

Disclaimer: Products in this specification manual must by regulation be installed by licensed and registered trade people. The manufacturer/distributor reserves the right to vary specifications or delete models from their range without prior notification. Dimensions are nominal measurements only. Dimensions and set-outs listed are correct at time of publication however the manufacturer/distributor takes no responsibility for printing errors. All ABI Products are designed in Australia. Copyright ABI Interiors Pty Ltd 2021.

INSTALLATION GUIDE

Note: This product must be installed by a licensed plumber. This is a general installation guide - there are many factors that are involved that can alter the installation method.

Note: In wall not included in handle kit.

- 1 Fasten screws to secure the shower mixer assembly in place.

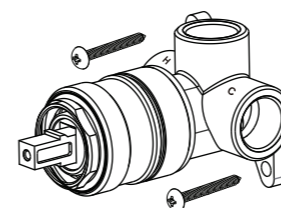

- 2 Attach water supply and water outlet. TEST AND CHECK FOR LEAKS

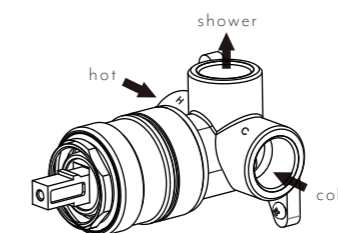

- 3 Create a 45mm round hole in cement sheet and tiles

Push the sleeve over the body until it is as far back as possible. Screw the dome onto the brass fitting and tighten

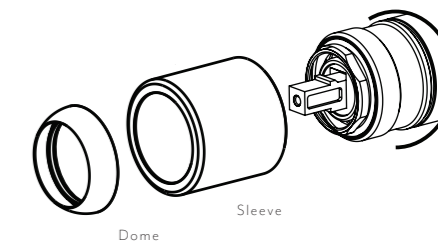

Please ensure that the hole is big enough to allow for the sleeve to slide on at fit-off stage

- 4 Assemble the plate and fix it in place.

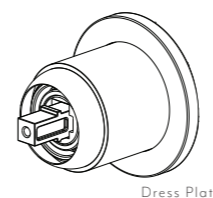

- 5 Push in the rubber gasket to mixer handle. Fasten the grub screw firmly with the allen key

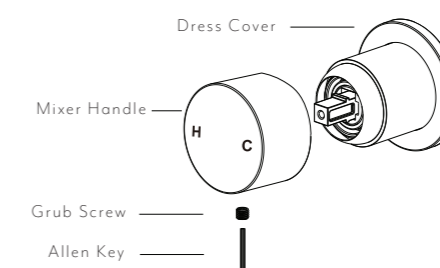

PROGRESSIVE MIXER OPERATION

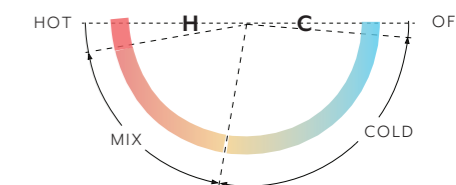

WHATS IN THE BOX

EXPLODED VIEW

Item Description Code

- 1 Handle
- 2 Dome
- 3 Sleeve
- 4 Back Plate

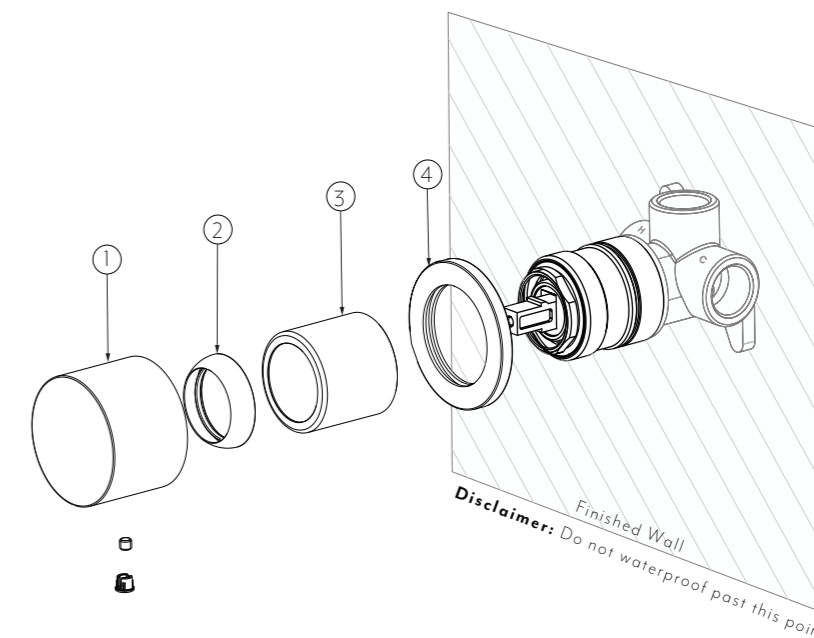

Disclaimer: Do not waterproof past this point