

## SPECIFICATIONS

### RECOMMENDED USE

Domestic

### COLOUR AVAILABILITY



### PRESSURE RATING

Recommended minimum working pressure 150kPa  
 Recommended maximum working pressure 500kPa  
 Hot and cold water inlet pressure should be equal

### TEMPERATURE RATING

Maximum continuous working temperature 75°C  
 If the water temperature exceeds 75°C, an approved tempering valve must be fitted

### SUITABLE HOT WATER UNITS

Storage tank: Yes  
 Continuous Flow: Yes  
 Gravity Feed: Not suitable

### STANDARDS

WELS Star Rating(5 Star) – Nominal Flow Rate(5.5 L/M)  
 Registration No.(T32356)

### WARRANTY

Structure: 25 years | Finish: 5 years | Cartridge: 10 years

# INSTALLATION MANUAL

This product must be installed by a qualified plumber.

- 1 Fasten screws to secure the shower mixer assembly in place.

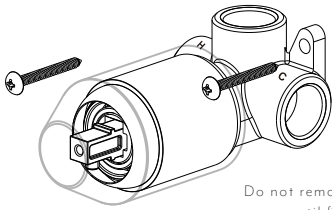

Do not remove the protective cover until final fit off.

- 2 Attach water supply and water outlet. TEST AND CHECK FOR LEAKS

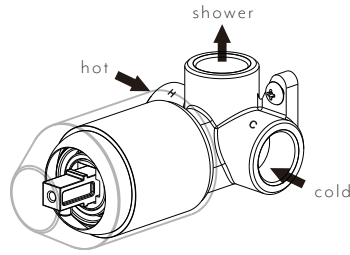

- 3 Create a 45mm round hole in cement sheet and tiles

Remove the protective cover. Push the dress plate over the shower mixer assembly gently.

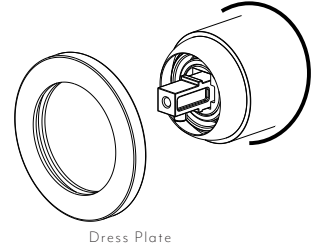

- 4 Assemble the plate and fix it in place.

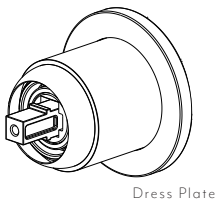

- 5 Push in the rubber gasket to mixer handle. Fasten the grub screw firmly with the allen key

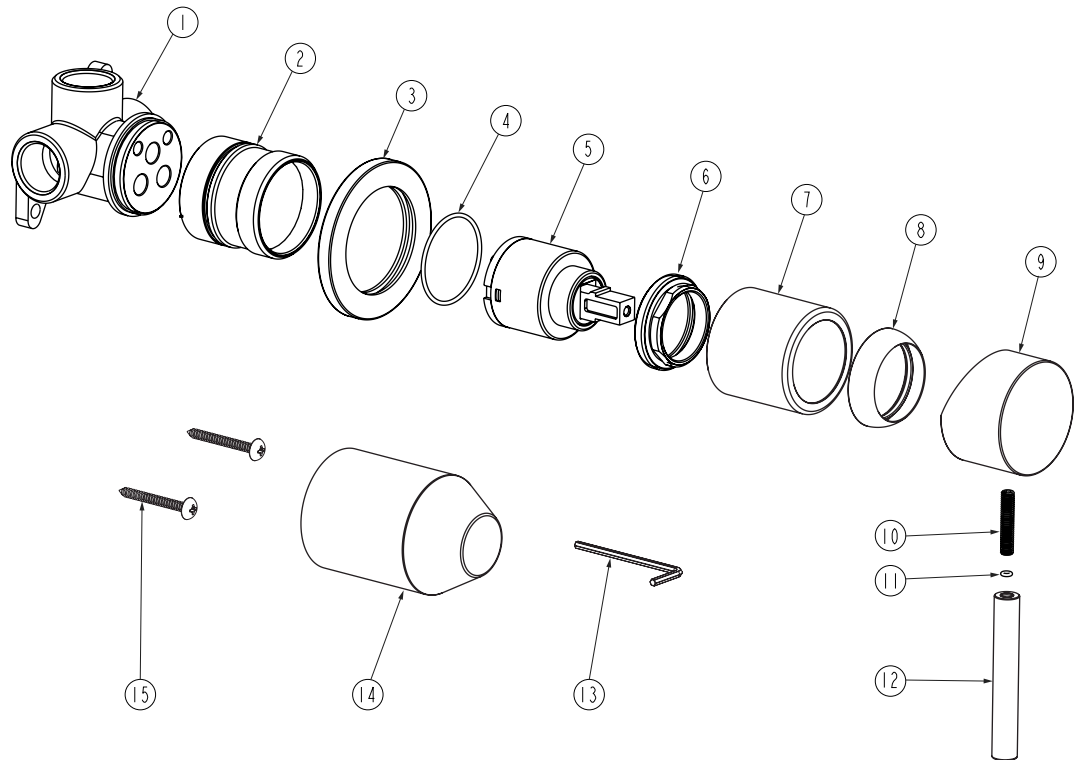
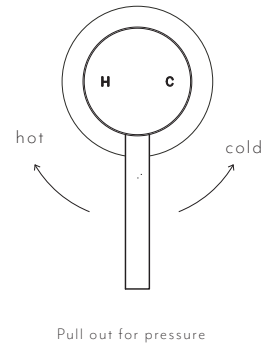
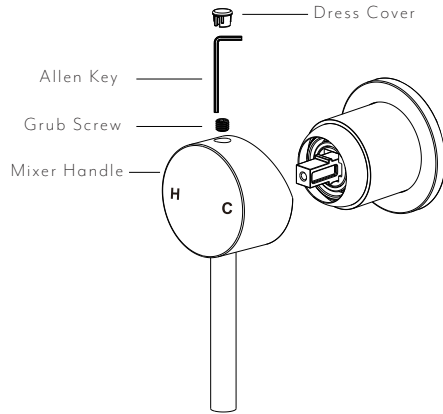

## EXPLODED VIEW

Item Description Code

- 1-2 Body
- 3 Back Plate
- 4 Rubber Ring
- 5 Cartridge
- 6 Locking Nut
- 7 Sleeve
- 8 Dome
- 9-12 Handle
- 13 Allen Key
- 14 Protective Case
- 15 Fixing Screws



Regularly clean with mild liquid detergent or soap and water



DO NOT use cream cleaners or bleach. These substances are abrasive

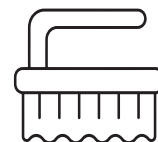

DO NOT use cleaning pads with abrasive surfaces as this may scratch the material